

Peak Emission Wavelength: 310nm, 325nm, 340nm

The MTE-F13 series UV emitter is a specifically designed for applications requiring high radiant power output and accuracy in a TO-39 hermetically sealed package with a special UV glass lens for optimum life time and device performance. Custom package solutions and sorting are available.

FEATURES

- > Hermetically Sealed TO-39
- > High Reliability
- > Wide Viewing Angle

APPLICATIONS

- > UV Curing / Light Therapy
- > Drug Discovery / Optical Sensor
- > DNA / Protein Analysis

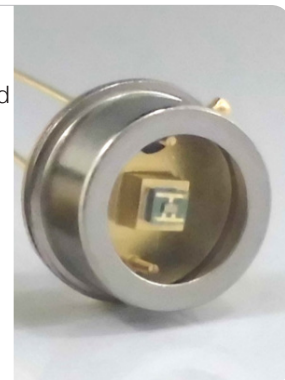

Absolute Maximum Ratings (Ta=25°C)



ITEMS	SYMBOL	RATINGS	UNIT
Forward Current	IF	40	mA
Operating Temperature	Topr	-30 ~ +80	°C
Storage Temperature	Tstg	-40 ~ +100	°C
Soldering Temperature*1	Tsol	250	°C

*1: Within 5 seconds.

Electrical & Optical Characteristics (Ta = 25°C)

ITEMS	SYMBOL	CONDITIONS	MTE310F13-UV	MTE325F13-UV	MTE340F13-UV	UNIT
Peak Wavelength	λ_p	IF=20mA	310±5	325±5	340±5	nm
Power Output	PO	IF=20mA	1.5	1.7	1.7	mW
Spectral Line Half Width	$\Delta\lambda$	IF=20mA	15	11	9	nm
Forward Voltage	VF	IF=20mA	5	4.5	4.0	V
Viewing Angle	$2\theta_{1/2}$	IF=20mA	114	114	114	deg
Rise Time*1	Tr	--	16	20	12	ns
Fall Time*1	Tf	--	8	9	8	ns

*1: Test Condition: Frequency=100KHz, duty=1%, Ifp=200mA

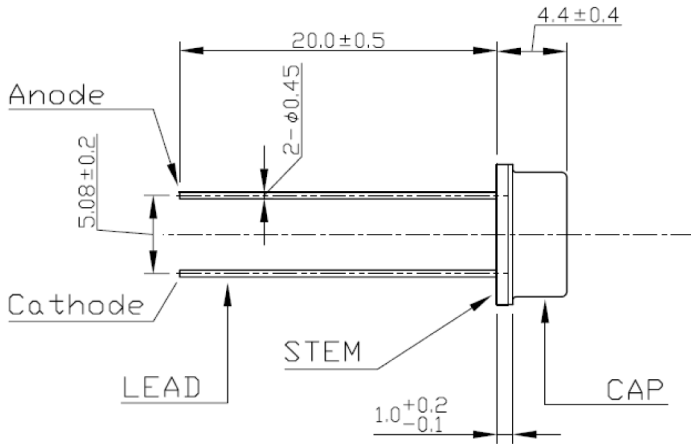

Note: Lead closest to the "tab" is the Cathode lead.

	ITEM	MATERIALS
1	GLASS	UV-GLASS
2	CAP	KOVAR, Ni Plating
3	STEM	SPCE, Au Plating
4	LEAD	Fe-Ni alloy, Au Plating

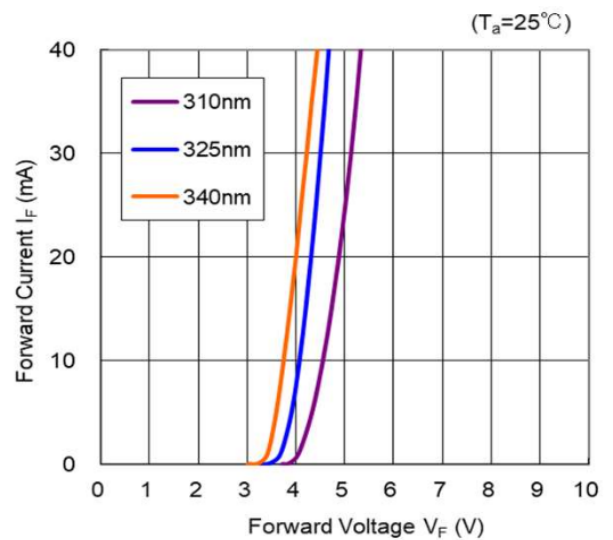
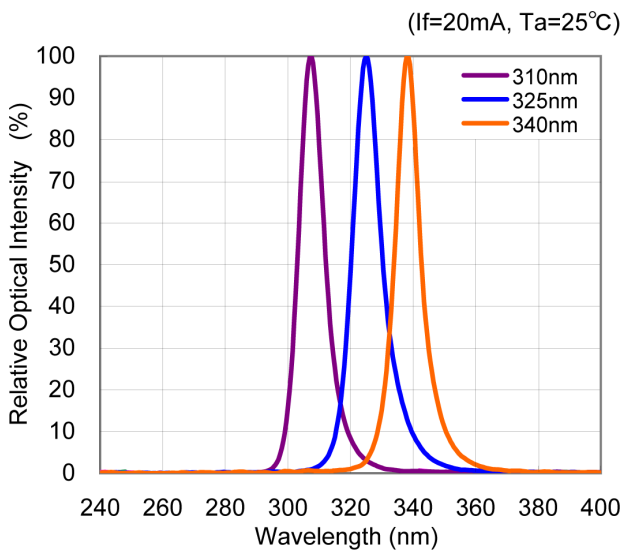
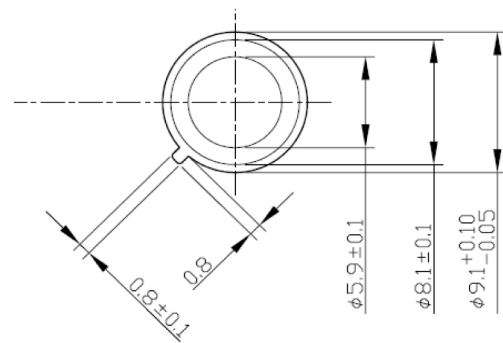

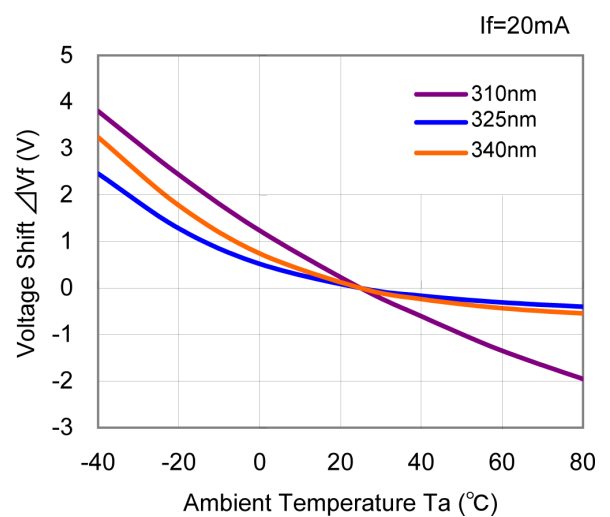
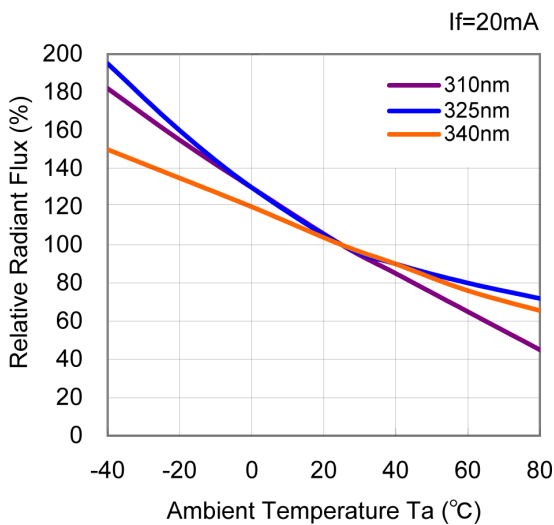
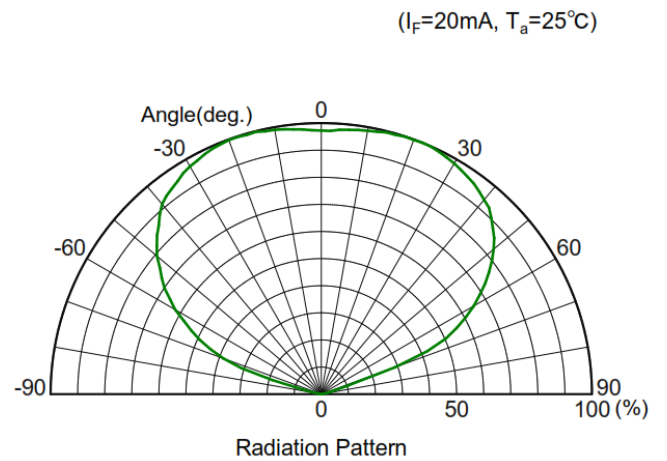
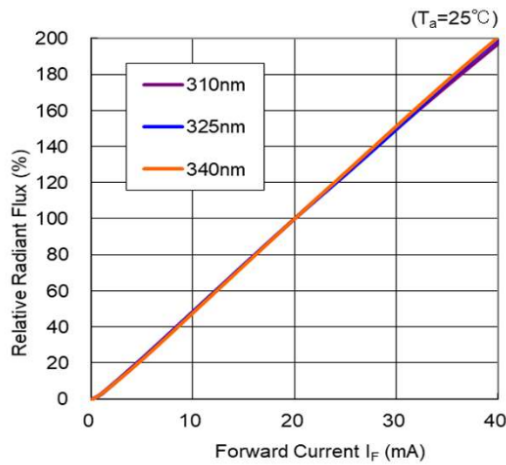

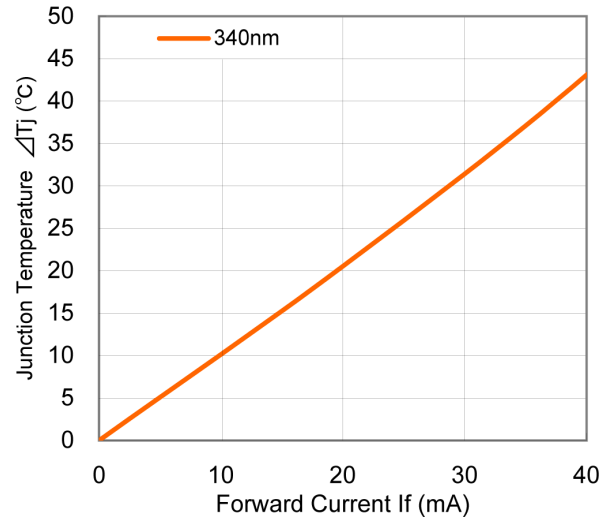
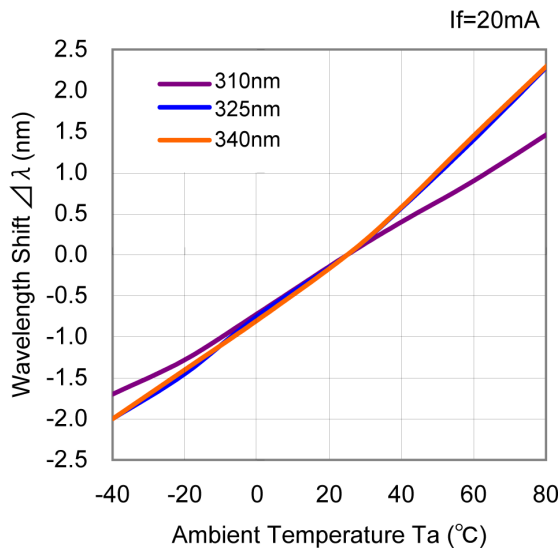

CAUTION

1. LEDs emit very strong UV radiation during operation.
2. Don't look directly into the LED light when in operation as UV radiation can harm your eyes.
3. To prevent even inadequate exposure, wear protective eyewear.
4. If LEDs are embedded in devices, please indicate warning labels against the UV LED used.
5. Avoid prolonged exposure to skin or other tissue during operation.
6. Keep out of reach of children.
7. Take appropriate precautions around pets and other living organisms to avoid UV exposure.
8. Specification and dimension are subject to change without notice.